

# SBL 50-2i

## 2V 50Ah

SBL 50-2i is a High Performance battery with 10-12 years in standby service or more than 350 cycles at 50% depth of discharge in cycle service.

### ☆ SPECIFICATION

● NOMINAL VOLTAGE	: 2V
● NOMINAL CAPACITY(10 hr)	: 50Ah
● DIMENSIONS	
TOTAL HEIGHT	: 166 mm ( 6.54 inches )
CONTAINER HEIGHT	: 166 mm (6.54 inches )
LENGTH	: 161 mm ( 6.34 inches )
WIDTH	: 50 mm ( 1.97 inches )
● WEIGHT	: APPROX 3.2Kg ( 7.06 lbs )
● CONTAINER MATERIAL	: UL94HB ABS
	: UL94V-0 ABS
● INTERNAL RESISTANCE( 25°C , 77 °F )	: ~1.0m
● DISCHARGE CAPACITY UNDER DIFFERENT TEMPERATURES	
40°C	: ~102%
25°C	: ~100%
0 °C	: ~85%

### ☆ CHARACTERISTICS

● CAPACITY 25°C/77°F	
10hr @ 5A	:50 Ah
5hr @ 8.5A	: 42.5 Ah
1hr @ 31.5A	: 31.5 Ah
1C @ 50A	: 25 Ah
● CAPACITY 25°C/77°F	
STANDBY USE	:2.25V~2.3V
CYCLE USE	:2.35V ~2.45V
● MAX DISCHARGE CURRENT	:250A (5sec)
● MAX CHARGING CURRENT	:10A
● SELF-DISCHARGE RESIDUAL CAPACITY	
AFTER 3 MONTHS	:~90%
AFTER 6 MONTHS	:~82%
AFTER 12 MONTHS	:~70%

### ☆ Discharge Current vs Time

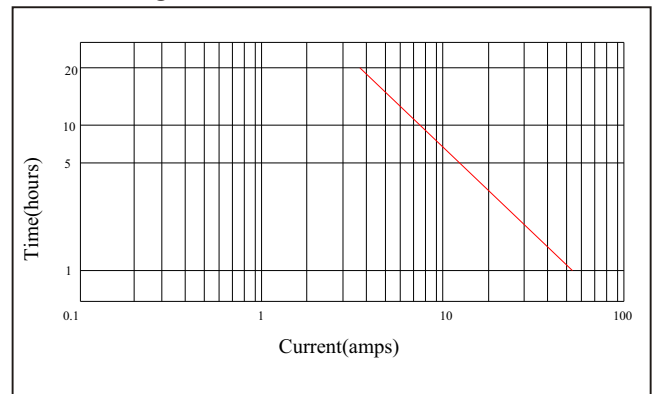

### ☆ Discharge Characteristics @25 °C (77 °F)

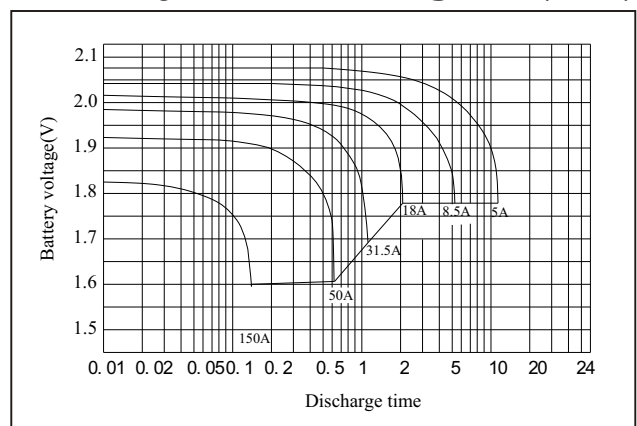

### ☆ Dimensions

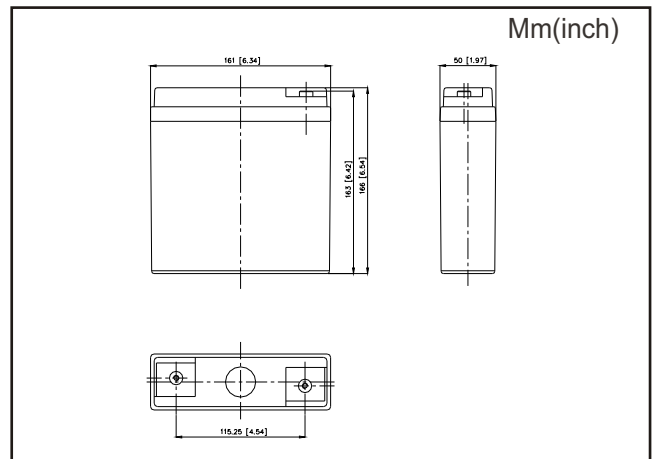

### ☆ Terminal

